



AF09 ... AF96 3-pole contactors

Accessory fitting details

For AF09 ... AF38 contactors + CE5 auxiliary contacts for severe industrial environments

Main accessory fitting details

Many configurations of accessories are possible depending on whether these are front-mounted or side-mounted.

Contactor types	Main poles 	Built-in auxiliary contacts 	Front-mounted accessories			Side-mounted accessories	
			Auxiliary contact blocks		Electronic timer mechanical interlock set (between 2 contactors) VEM4	Auxiliary contact blocks	
			1-pole CE5	1-pole CA4 1-pole CC4		Left side 2-pole CAL4-11	Right side

3-pole contactors AF09 ... AF38

Max. N.C. built-in and add-on N.C. auxiliary contacts (CA4, CC4, CAL4, VEM4):
2 max. with 1 CE5, none with 2 CE5 on positions 1, 2, 3, 4

AF09 ... AF16	3 0	0 1	1	+	3 max.	-	+	1	-
AF09 ... AF16	3 0	1 0	2	+	2 max.	-	-	-	-
AF26 ... AF38	3 0	0 0	1	+	3 max.	-	+	1	-
			1	+	1 max.	-	+	1	+ 1
			1	+	2 max.	+ 1	+	1	-
1 max. N.C. built-in and add-on N.C. auxiliary contacts (CA4, CC4, CAL4, VEM4) on positions 1 ±30°, 5									
AF09 ... AF16	3 0	0 1	1	+	3 max.	-	-	-	-
AF09 ... AF16	3 0	1 0	1	+	3 max.	-	+	1	-
AF26 ... AF38	3 0	0 0	1	+	2 max.	+ 1	-	-	-

4-pole contactors AF09 ... AF38

Max. add-on N.C. auxiliary contacts (CA4, CC4, CAL4, VEM4):
2 max. with 1 CE5, none with 2 CE5 on positions 1, 2, 3, 4

AF09, AF16	4 0	0 0	2	+	2 max.	-	-	-	-
			1	+	3 max.	-	+	1	-
			1	+	1 max.	-	+	1	+ 1
			1	+	2 max.	+ 1	+	1	-
1 max. add-on N.C. auxiliary contacts (CA4, CC4, CAL4, VEM4) on positions 1, 2, 3, 4									
AF26, AF38	4 0	0 0	1	+	3 max.	-	+	1	-
			1	+	2 max.	+ 1	-	-	-
AF09, AF16	2 2	0 0	1	+	3 max.	-	+	1	-
AF26, AF38	2 2	0 0							
1 max. add-on N.C. auxiliary contacts (CA4, CC4, CAL4, VEM4) on positions 1 ±30°, 5									
AF09, AF16	4 0	0 0	1	+	3 max.	-	+	1	-
			1	+	2 max.	+ 1	-	-	-
No add-on N.C. auxiliary contacts on positions 1 ±30°, 5									
AF26, AF38	4 0	0 0	1	+	3 max.	-	-	-	-
AF09, AF16	2 2	0 0							
AF26, AF38	2 2	0 0							

AF116 ... AF370 3-pole contactors with 1 N.O. + 1 N.C. auxiliary contacts

Accessory fitting details

Main accessories (other accessories available)

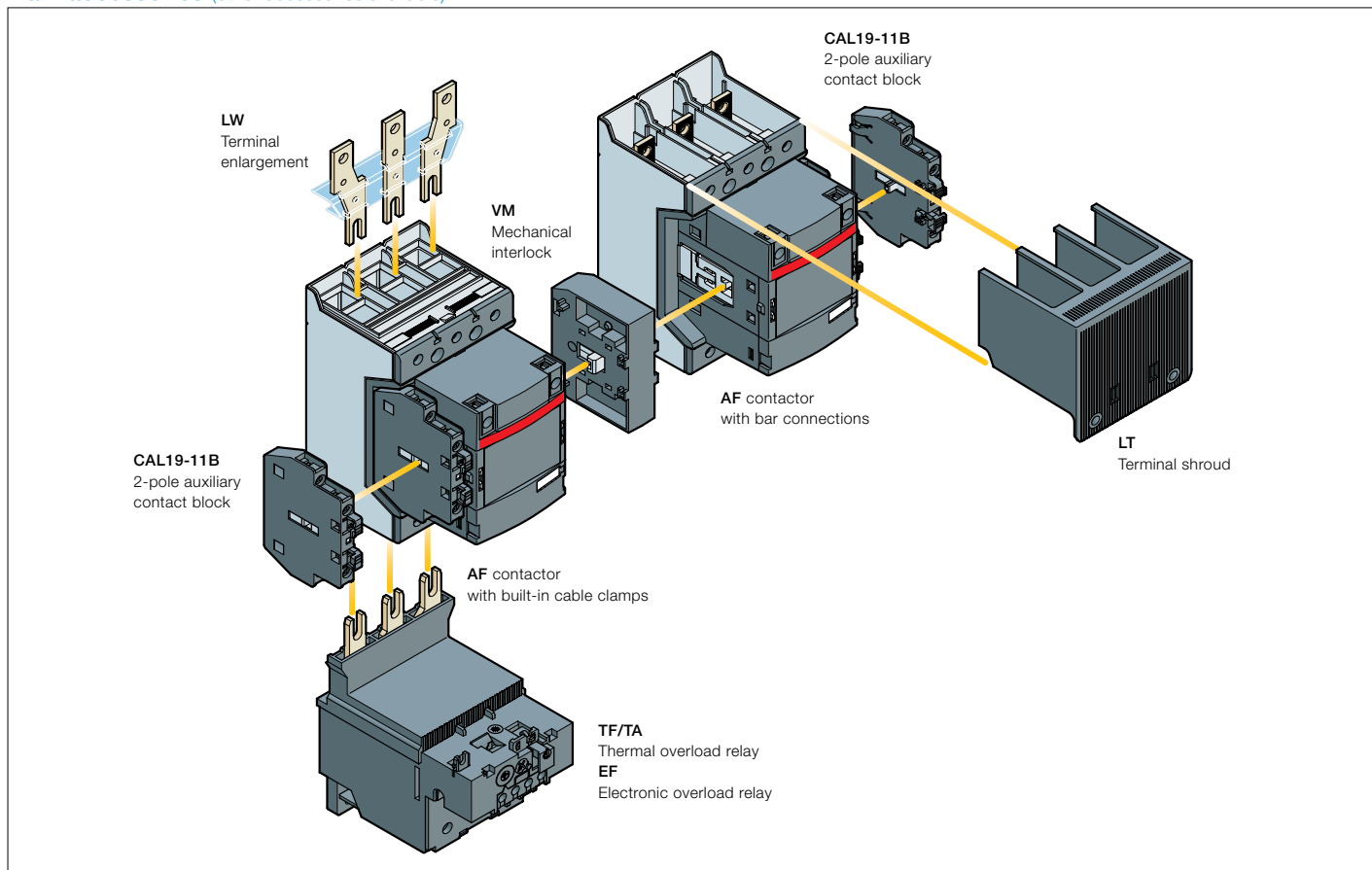

Main accessory fitting details

Contactor types	Main poles	Available auxiliary contacts	Side-mounted accessories		
			Auxiliary contact blocks		Mechanical interlock units (between two contactors)
			CAL19-11	CAL19-11B	
AF116 ... AF370	3	0 1 1	1 x CAL19-11	+ 2 x CAL19-11B	-
AF116 ... AF370	3	0 1 1	-	+ 2 x CAL19-11B (1)	+ VM... (2)

(1) Total number of auxiliary contact blocks for the two contactors.

(2) Interlock type, according to the contactor ratings (see "Accessories").

Overload relays fitting details (1)

Contactor types	Thermal overload relays	Electronic overload relays
AF116 ... AF140	TF140DU (66...142 A)	EF146 (54...150 A)
AF146	-	EF146 (54...150 A)
AF190, AF205	TA200DU (66...200 A)	EF205 (63...210 A)
AF265 ... AF370	-	EF370 (115...380 A)

The addition of a thermal or electronic overload relay on the contactor does not prevent fitting of many other accessories as shown in "Main accessory fitting details" table.

(1) Direct mounting - No kit required.

AF400 ... AF2650 3-pole contactors with 1 N.O. + 1 N.C. auxiliary contacts Accessory fitting details

Main accessories (other accessories available)

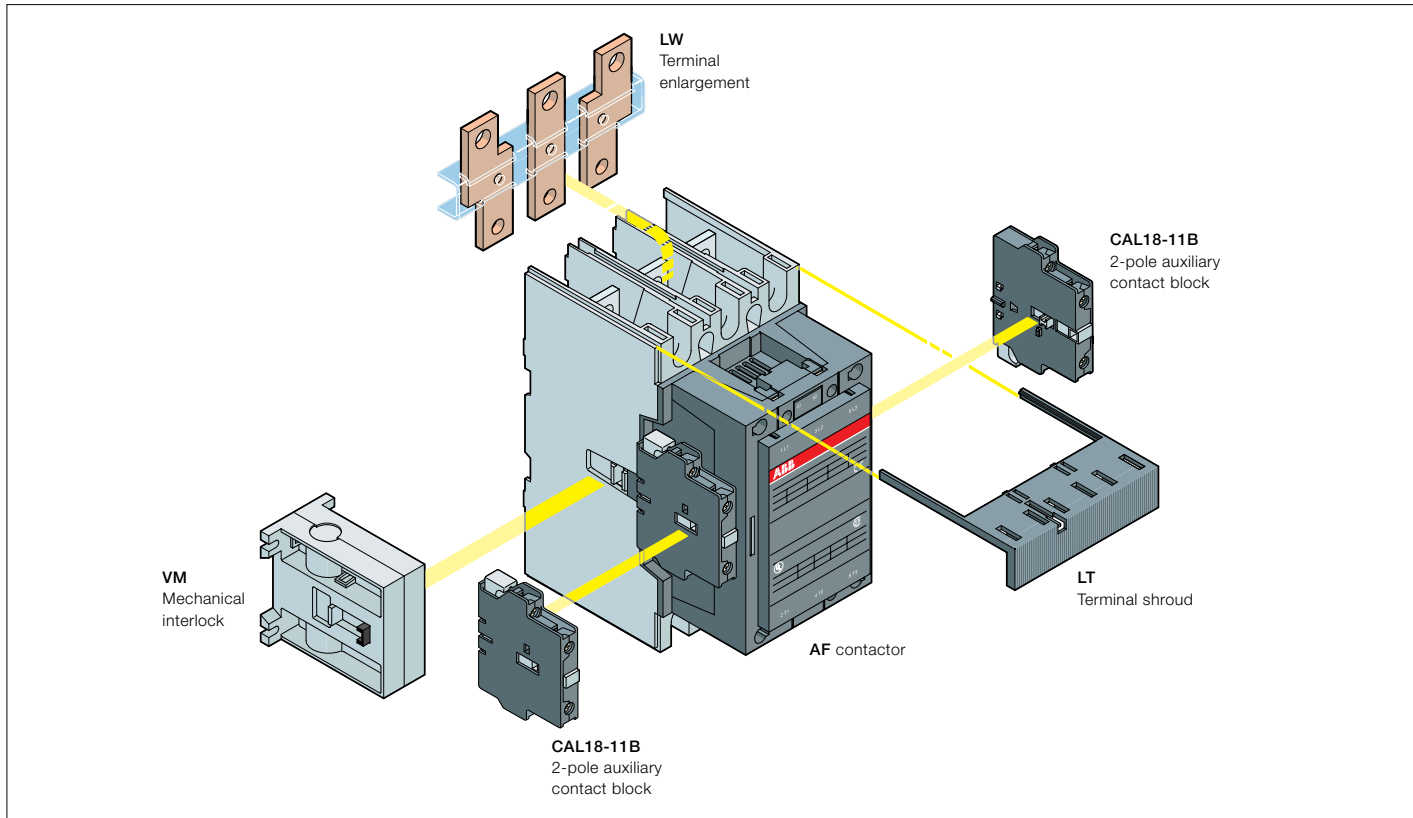

Main accessory fitting details

Contactor types	Main poles	Available auxiliary contacts	Side-mounted accessories		
			Auxiliary contact blocks		
			CAL18-11	CAL18-11B (3)	Mechanical interlock units (between two contactors)

Contactors + auxiliary contact blocks

AF400 ... AF2650	3	0	1	1	1 x CAL18-11	+	2 x CAL18-11B	-
------------------	---	---	---	---	--------------	---	---------------	---

Contactors with mechanical interlocking + auxiliary contact blocks

AF400 ... AF2650	3	0	1	1	2 x CAL18-11 (1)	+	4 x CAL18-11B (1)	+	VM...H (2)
------------------	---	---	---	---	------------------	---	-------------------	---	------------

(1) Total number of auxiliary contact blocks for the two contactors. (2) Interlock type, according to the contactor ratings (see "Accessories").
(3) The CEL18-... auxiliary contact blocks can replace the CAL18-11 and CAL18-11B. Though, no auxiliary contact block can be mounted outside the CEL18-...

Overload relays fitting details

Contactor types	Thermal overload relays	Electronic overload relays
AF400, AF460	-	E500DU (150...500 A) (4)
AF580, AF750	-	E800DU (250...800 A) (4)
AF1350, AF1650	-	E1250DU (375...1250 A) (4)

The addition of a thermal or electronic overload relay on the contactor does not prevent fitting of many other accessories as shown in "Main accessory fitting details" table.
(4) Mounting kit required (see overload relay page).

AF09 ... AF38 4-pole contactors

Accessory fitting details

Contactor and main accessories (other accessories available)

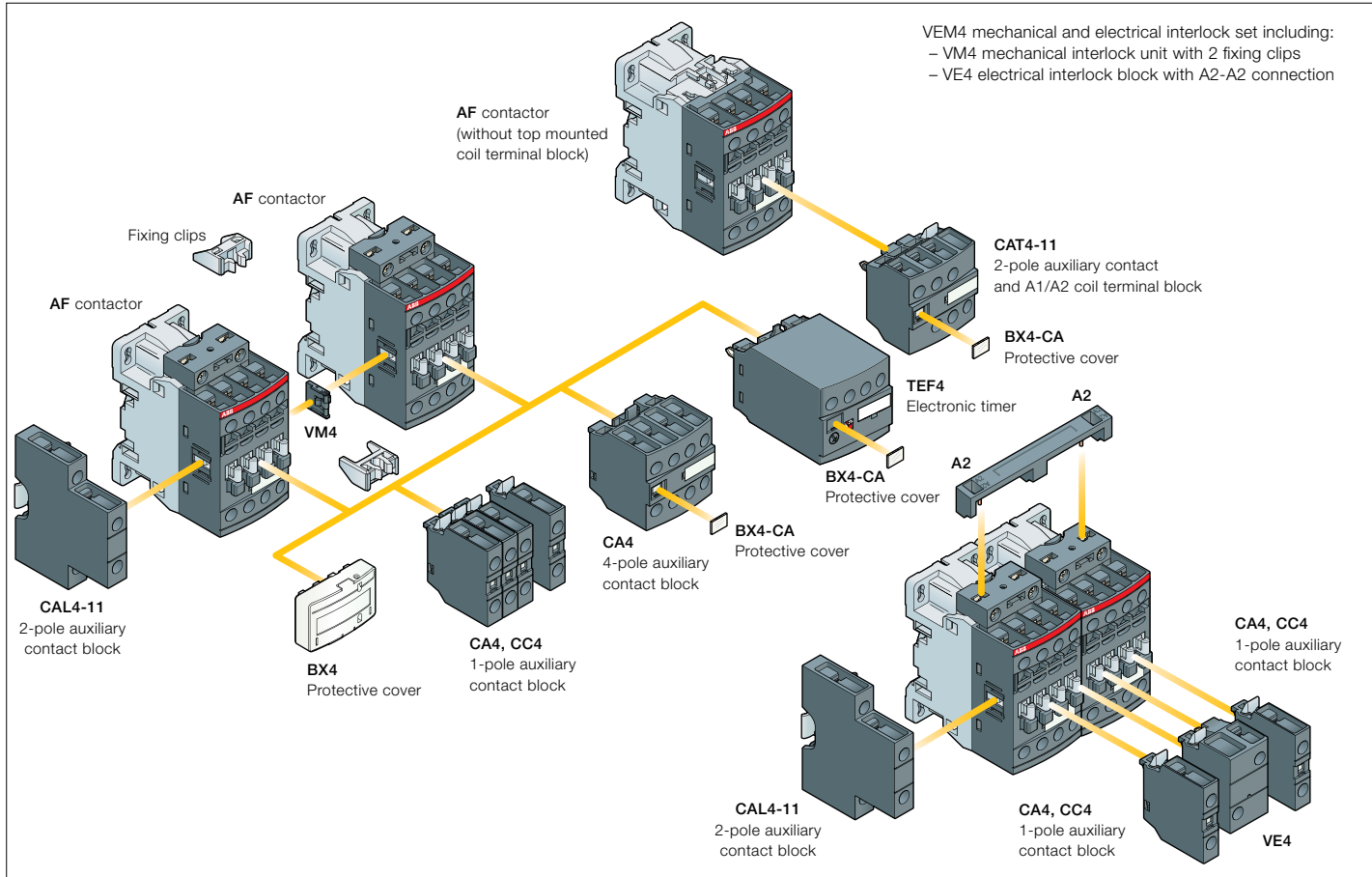

Main accessory fitting details

Many configurations of accessories are possible depending on whether these are front-mounted or side-mounted.

Contactor types	Main poles	Built-in auxiliary contacts	Front-mounted accessories				Side-mounted accessories			
			Auxiliary contact blocks			Electronic timer	Electrical and mechanical interlock set (between 2 contactors)	Auxiliary contact blocks		
			1-pole CA4 1-pole CC4	2-pole CAT4-11	4-pole CA4	TEF4	VEM4	Left side 2-pole CAL4-11	Right side	
Max. add-on N.C. auxiliary contacts: 4 N.C. max. on positions 1, 2, 3, 4 and 3 N.C. max. on positions 1 ±30°, 5										
AF09 ... AF16	4	0	0	0	4 max. 2 max. 3 max.	or 1 or 1 -	or 1 or 1 -	- - + 1	+ 1 + 1 + 1	- + 1 or 1
Max. add-on N.C. auxiliary contacts: 3 N.C. max. on positions 1, 2, 3, 4 and 2 N.C. max. on positions 1 ±30°, 5										
AF26 ... AF38	4	0	0	0	4 max. 2 max. 3 max.	or 1 or 1 -	or 1 or 1 -	- - + 1	+ 1 + 1 + 1	- + 1 or 1
AF09 ... AF16	2	2	0	0	4 max.	or 1	or 1	-	+ 1	-
AF26 ... AF38	2	2	0	0	2 max.	or 1	or 1	-	+ 1	+ 1

NF 4-pole control relays

Accessory fitting details

Control relays and main accessories (other accessories available)

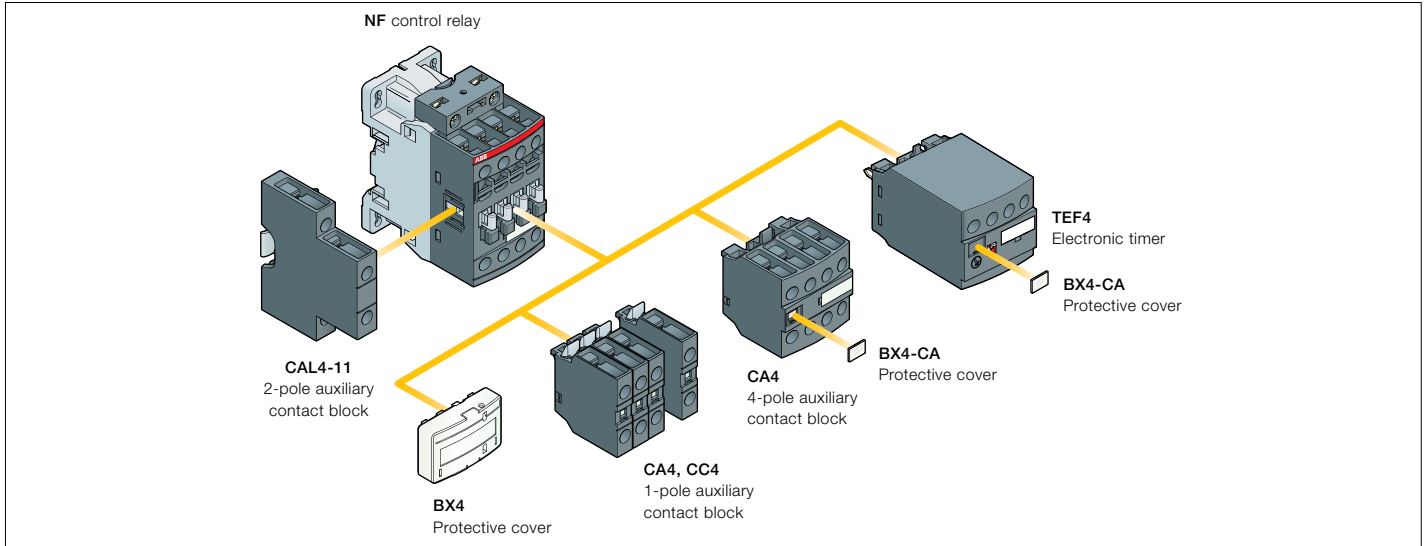

Main accessory fitting details

Many configurations of accessories are possible depending on whether these are front-mounted or side-mounted.

Control relay types	Main poles	Front-mounted accessories			Electronic timer	Side-mounted accessories		
		Auxiliary contact blocks			TEF4	Left side	Right side	
		1-pole CA4	1-pole CC4	4-pole CA4		2-pole CAL4-11		
Max. add-on N.C. auxiliary contacts: 3 N.C. max. on positions 1, 2, 3, 4 and 2 N.C. max. on positions 1 ±30°, 5								
NF	2 2 E 3 1 E	4 max.	or 1		or 1	+ 1	-	
		2 max.	-		or 1	+ 1	+ 1	
Max. add-on N.C. auxiliary contacts: 4 N.C. max. on positions 1, 2, 3, 4 and 3 N.C. max. on positions 1 ±30°, 5								
NF	4 0 E	4 max.	or 1		or 1	+ 1	-	
		2 max.	-		or 1	+ 1	+ 1	

For NF control relays + CE5 auxiliary contacts for severe industrial environments

Main accessory fitting details

Many configurations of accessories are possible depending on whether these are front-mounted or side-mounted.

Control relay types	Main poles	Front-mounted accessories			Side-mounted accessories	
		Auxiliary contact blocks			Left side	Right side
		1-pole CE5	1-pole CA4	1-pole CC4	2-pole CAL4-11	
Max. add-on N.C. auxiliary contacts (CA4, CC4, CAL4): 1 max. with 1 CE5 on positions 1, 2, 3, 4						
NF	2 2 E 3 1 E	1	+ 3 max.		+ 1	-
Max. add-on N.C. auxiliary contacts (CA4, CC4, CAL4): 2 max. with 1 CE5, none with 2 CE5 on positions 1, 2, 3, 4						
NF	4 0 E	2	+ 2 max.	-	-	-
		1	+ 3 max.	-	+ 1	-
		1	+ 1 max.	-	+ 1	+ 1
Max. add-on N.C. auxiliary contacts (CA4, CC4): none with 1 CE5 on positions 1 ±30°, 5						
NF	2 2 E 3 1 E	1	+ 3 max.	-	-	-
Max. add-on N.C. auxiliary contacts (CA4, CC4, CAL4): 1 max. with 1 CE5 on positions 1 ±30°, 5						
NF	4 0 E	1	+ 3 max.	-	+ 1	-

NF 8-pole control relays

Accessory fitting details

Control relays and main accessories (other accessories available)

2

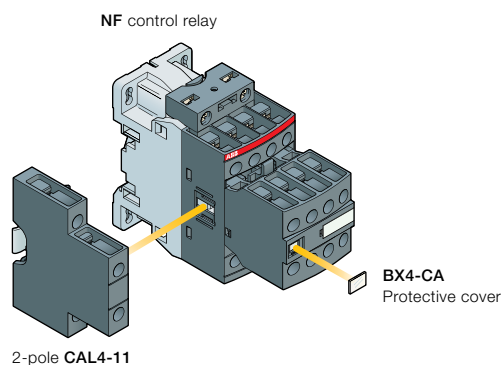

Main accessory fitting details

Many configurations of accessories are possible depending on whether these are front-mounted or side-mounted.

Control relay types	Main poles	Front-mounted accessories				Side-mounted accessories																
		Auxiliary contact blocks				Auxiliary contact blocks																
		1-pole CA4	1-pole CC4	4-pole CA4		Left side	Right side															
						2-pole CAL4-11																
NF	<table border="0"> <tr> <td>4</td> <td>4</td> <td>E</td> </tr> <tr> <td>5</td> <td>3</td> <td>E</td> </tr> <tr> <td>6</td> <td>2</td> <td>E</td> </tr> <tr> <td>7</td> <td>1</td> <td>E</td> </tr> <tr> <td>8</td> <td>0</td> <td>E</td> </tr> </table>	4	4	E	5	3	E	6	2	E	7	1	E	8	0	E	-		-	+	1	-
4	4	E																				
5	3	E																				
6	2	E																				
7	1	E																				
8	0	E																				

Auxiliary contact blocks for AF09 ... AF96 contactors and NF control relays



CA4-10



CAL4-11



CA4-22E



CAT4-11E

Description

The auxiliary contact blocks are used for the operation of auxiliary circuits and control circuits for standard industrial environments.

Types of auxiliary contact blocks for front mounting:

- CA4 1 or 4-pole block, with instantaneous N.O., N.C. contacts
- CC4 1-pole block, with N.O. leading contact or N.C. lagging contact
- CAT4 2-pole block, with instantaneous N.O. + N.C. contacts and A1 / A2 coil terminal connection on front face.

Select the 4-pole auxiliary contact blocks CA4-..E, CA4-..M, CA4-..U or CA4-..N type, according to the contactor or contactor relay type for compliance with the standard requirements (see "Terminal marking and positioning").





Types of auxiliary contact blocks for side mounting:

- CAL4 2-pole block, with instantaneous N.O. + N.C. contacts.

For clipping onto the right- and/or left-hand side of the contactors.

The auxiliary contact blocks are equipped with screw type connecting terminals delivered open, protected against accidental direct contact and bear the corresponding function marking.

Ordering details (1)

For contactors	Auxiliary contacts	Catalog number	Global reference code	Pkg qty	Weight (1 pce)
	   				kg

Front-mounted instantaneous auxiliary contact blocks

AF09 ... AF96 4-pole NF	1	0	-	-	CA4-10	1SBN010110R1010	1	0.014
	1	0	-	-	CA4-10-T	1SBN010110T1010	10	0.014
	0	1	-	-	CA4-01	1SBN010110R1001	1	0.014
	0	1	-	-	CA4-01-T	1SBN010110T1001	10	0.014
AF09 ... AF16..-30-10	2	2	-	-	CA4-22M	1SBN010140R1122	1	0.055
	3	1	-	-	CA4-31M	1SBN010140R1131	1	0.055
	1	3	-	-	CA4-13M	1SBN010140R1113	1	0.055
	0	4	-	-	CA4-04M	1SBN010140R1104	1	0.055
AF26 ... AF96..-30-00 AF09 ... AF38..-40-00 AF09 ... AF38..-22-00	2	2	-	-	CA4-22E	1SBN010140R1022	1	0.055
	3	1	-	-	CA4-31E	1SBN010140R1031	1	0.055
	4	0	-	-	CA4-40E	1SBN010140R1040	1	0.055
	0	4	-	-	CA4-04E	1SBN010140R1004	1	0.055
AF09 ... AF16..-30-01	2	2	-	-	CA4-22U	1SBN010140R1322	1	0.055
	3	1	-	-	CA4-31U	1SBN010140R1331	1	0.055
	4	0	-	-	CA4-40U	1SBN010140R1340	1	0.055
	4-pole NF	2	2	-	-	CA4-22N	1SBN010140R1222	1
3		1	-	-	CA4-31N	1SBN010140R1231	1	0.055
4		0	-	-	CA4-40N	1SBN010140R1240	1	0.055
1		3	-	-	CA4-13N	1SBN010140R1213	1	0.055
NF..40E	0	4	-	-	CA4-04N	1SBN010140R1204	1	0.055

Front-mounted auxiliary contact blocks with N.O. leading contact and N.C. lagging contact

AF09 ... AF96 4-pole NF	-	-	1	0	CC4-10	1SBN010111R1010	1	0.014
	-	-	0	1	CC4-01	1SBN010111R1001	1	0.014

Side-mounted instantaneous auxiliary contact blocks

AF09 ... AF96 NF	1	1	-	-	CAL4-11	1SBN010120R1011	1	0.040
	1	1	-	-	CAL4-11-T	1SBN010120T1011	10	0.040

Front-mounted instantaneous auxiliary contact and A1/A2 coil terminal blocks

AF09 ... AF16..-30-10	1	1	-	-	CAT4-11M	1SBN010151R1111	1	0.040
AF26 ... AF65..-30-00 AF09 ... AF38..-40-00 AF09 ... AF38..-22-00	1	1	-	-	CAT4-11E	1SBN010151R1011	1	0.040
AF09 ... AF16..-30-01	1	1	-	-	CAT4-11U	1SBN010151R1311	1	0.040

(1) For each contactor or contactor relay type, refer to "Accessory fitting details" table.

Note: CAT4 not suitable for AF.Z contactors with DC control voltage 12...20 V DC.

Auxiliary contact blocks for AF116 ... AF2650 contactors

2



CAL19-11

Description

The auxiliary contact blocks are used for the operation of auxiliary circuits and control circuits for standard industrial environments.

Types of auxiliary contact blocks for side mounting:



- CAL 2-pole block, with instantaneous N.O. + N.C. contacts.

For clipping onto the right- and/or left-hand side of the contactors.

The CAL ...-11B is a second block for mounting in addition to a first CAL ...-11 block, right- and/or left-hand of the AF116 ... AF2650 contactors.

The auxiliary contact blocks are equipped with screw type connecting terminals delivered open, protected against accidental direct contact and bear the corresponding function marking.

Ordering details

For contactors	Auxiliary contacts	Catalog number	Global reference code	Pkg qty	Weight (1 pce)
	 				kg

Side-mounted instantaneous auxiliary contact blocks

AF116 ... AF370	1	1	CAL19-11	1SFN010820R1011	2	0.040
	1	1	CAL19-11B	1SFN010820R3311	2	0.040
AF400 ... AF2650	1	1	CAL18-11	1SFN010720R1011	2	0.050
	1	1	CAL18-11B	1SFN010720R3311	2	0.050

(1) For each contactor type, refer to "Accessory fitting details" table.



CAL18-11

Auxiliary contact blocks for AF09 ... AF38 contactors and NF control relays for severe industrial environments



CE5-10W

Description





The auxiliary contact blocks are used for the operation of auxiliary circuits and control circuits for severe industrial environments.

Types of auxiliary contact blocks for front mounting:

- CE5 1-pole block, instantaneous with N.O. contact or N.C. contact, available in 2 IP degrees
- CE5 D with built-in microswitch IP40, degree of protection (IP20 on terminals)
- CE5 W with built-in microswitch IP67, degree of protection (IP20 on terminals).

The auxiliary contact blocks are equipped with screw type connecting terminals delivered open, protected against accidental direct contact and bear the corresponding function marking.

Ordering details (1)

For contactors	Auxiliary contacts	Catalog number	Global reference code	Pkg qty	Weight (1 pce)
	   				kg
AF09 ... AF38	1 - - -	CE5-10D0.1	1SBN010015R1010	1	0.020
NF	- 1 - -	CE5-01D0.1	1SBN010015R1001	1	0.020
	1 - - -	CE5-10D2	1SBN010017R1010	1	0.020
	- 1 - -	CE5-01D2	1SBN010017R1001	1	0.020
	1 - - -	CE5-10W0.1	1SBN010016R1010	1	0.020
	- 1 - -	CE5-01W0.1	1SBN010016R1001	1	0.020
	1 - - -	CE5-10W2	1SBN010018R1010	1	0.020
	- 1 - -	CE5-01W2	1SBN010018R1001	1	0.020

(1) For each contactor type, refer to "Accessory fitting details" table.

Auxiliary contact blocks for AF400 ... AF2650 contactors for severe industrial environments

2



CEL18

Description

The auxiliary contact blocks are used for the operation of auxiliary and control circuits for severe industrial environments.



Types of auxiliary contact blocks for side mounting:

- CEL18 1-pole block, with built-in microswitch IP67 degree of protection (IP20 on terminals). Instantaneous N.O. or N.C. contact.

For clipping onto the right- and/or left-hand side of the contactors.

The auxiliary contact blocks are equipped with screw type connecting terminals delivered open, protected against accidental direct contact and bear the corresponding function marking.

Ordering details (1)

For contactors	Auxiliary contacts	Catalog number	Global reference code	Pkg qty	Weight (1 pce)
	 				kg
Side-mounting instantaneous auxiliary contact blocks					
AF400 ... AF2650	1 0	CEL18-10	1SFN010716R1010	1	0.050
	0 1	CEL18-01	1SFN010716R1001	1	0.050

(1) For each contactor type, refer to "Accessory fitting details" table.

Impulse contact blocks

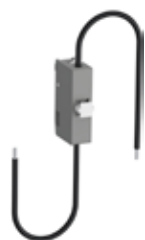

CB5

Description

Impulse contact blocks are designed for use in enclosures, in association with an adjustable mechanical pushbutton. Two types are available:

CB5-10: N.O. contact with a black actuator ("ON" function)

CB5-01: N.C. contact with a light grey actuator ("OFF" function).

These blocks are equipped with 2 connecting leads 0.5 mm² with end, approximately 18 cm long.

Mounting: Clipped onto the front face of the contactors.

Ordering details

For contactors	Contacts	Catalog number	Global reference code	Pkg qty	Weight (1 pce) kg
AF09 ... AF38	1 -	CB5-10	1SBN010013R1010	1	0.012
	- 1	CB5-01	1SBN010013R1001	1	0.012

Note: For AF40 ... AF96 mounting: please consult us.

Main dimensions mm, inches

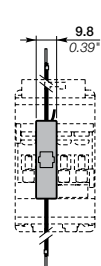

CB5-10

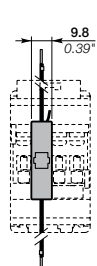
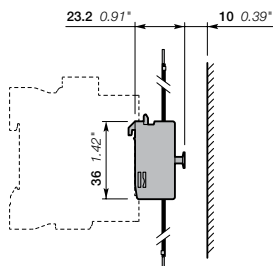

CB5-01

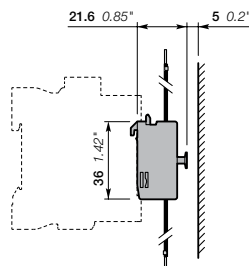

Electronic timers

2



TEF4-ON

Description

TEF4 front-mount electronic timers are used for timing function and are available in ON-delay and OFF-delay versions.

Compact solution in cabinet compared to separate timers

TEF4 electronic timers are front-mounted and clip on AF contactors or NF control relays. A mechanical indicator shows the state of the contactor.

Safe and cost-reduced wiring

TEF4 electronic timers are supplied by a direct plug-in parallel connection to the coil terminals A1 - A2 of the contactor or contactor relay. A varistor is integrated on the timer to offer a built-in protection against surges in the contactor coil.

Available for a wide control voltage range 24...240 V AC/DC

TEF4-ON or TEF4-OFF allow time-delayed functions up to 100 s in 3 distinct time ranges, independently of the control system. The time delay ranges are selected by a switch and the time delay can be adjusted by means of a rotary switch. The timing function is activated by closing or opening the device on which the timer is mounted. The OFF-delay version operates without additional control supply.



TEF4-OFF

Ordering details

For contactors, control relays	Time delay range selected by switch	Delay type	Rated control circuit voltage U_c	Auxiliary contacts	Catalog number	Global reference code	Weight Pkg (1 pce) kg
AF09 ... AF96 NF	0.1...1 s	ON-delay	24...240	1 1	TEF4-ON	1SBN020112R1000	0.065
	1...10 s 10...100 s	OFF-delay	24...240	1 1	TEF4-OFF	1SBN020114R1000	0.065



VM4



VM19

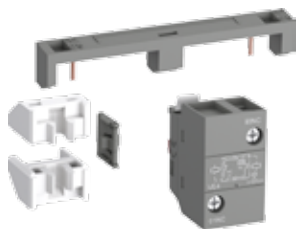

VEM4

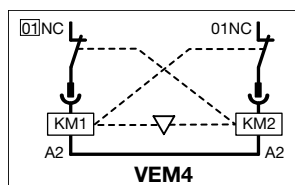

BB4

Mechanical interlock units

Description

The VM mechanical interlock units are designed for the interlocking of two AF contactors. When mounted between two contactors, the VM mechanical interlock unit prevents one of the contactors from closing as long as the other contactor is closed.

The mechanical interlock units VM4 and VM96-4 include 2 fixing clips.

Ordering details

For contactors	Mounting	Catalog number	Global reference code	Pkg qty	Weight (1 pce) kg
Mechanical interlock units for two contactors mounted side by side					
AF09 ... AF38...-30-... AF09 ... AF38...-40-00	Fixed between two contactors, mounted flush side by side	VM4	1SBN030105T1000	10	0.005
AF40 ... AF96		VM96-4	1SBN033405T1000	10	0.006
For same size contactors: AF116 ... AF146 AF190, AF205 AF265 ... AF370		VM19	1SFN030300R1000	1	0.054
AF116 ... AF146 and AF190, AF205		VM140/190	1SFN034403R1000	1	0.088
AF190, AF205 and AF265 ... AF370		VM205/265	1SFN035203R1000	1	0.090
AF400 ... AF1250	PN.. mounting plate to be ordered separately	VM750H	1SFN035700R1000	1	0.200
AF1350 ... AF2650	Plate included	VM1650H	1SFN036503R1000	1	6.000
Mechanical interlock units for two contactors mounted one above the other					
AF400 ... AF1250	Additional plate (not supplied)	VM750V	1SFN035701R1000	1	0.200

Mechanical and electrical interlock sets

Description

VEM4 mechanical and electrical interlock set for the interlocking of two AF contactors. VEM4 set includes a mechanical interlock unit VM4 with 2 fixing clips (BB4) and a VE4 electrical interlock block with A2-A2 connection.

Fixing the electrical interlock block to the contactor front face connects the 2 built-in N.C. interlocking contacts with the two coils. VE4 block must be used with A2-A2 connection to respect the electrical connection diagram.

Ordering details

For contactors	Auxiliary contacts	Catalog number	Global reference code	Pkg qty	Weight (1 pce) kg
Mechanical and electrical interlock set					
For same size contactors: AF09 ... AF16...-30-... AF26 ... AF38...-30-00 AF09, AF16...-40-00 AF26, AF38...-40-00	0 2	VEM4	1SBN030111R1000	1	0.035
Fixing clips					
AF09 ... AF38		BB4	1SBN110120W1000	50	0.002

Note: VEM4 not suitable for AF..Z contactors with DC control voltage 12...20 V DC.

Mechanical latching units

2



WB75-A

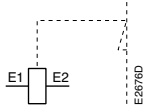

Terminal marking

Description

For converting standard contactors into latched contactors.

The WB75-A block contains a mechanical latching device with electromagnetic impulse unlatching (AC or DC) or manual unlatching.

Captive screw type connecting terminals, built-in cable clamps, M3.5 (+, -) pozidriv 2 screw with screwdriver guidance; delivered untightened and protected against accidental direct contact.

Operation

After closing, the contactor continues to be held in the closed position by the latching mechanism should the supply voltage fail at the contactor coil terminals.

Contact opening can be controlled:

- electrically by an impulse (AC or DC) on the WB75-A block coil.
(the coil is not designed to be permanently energized)
- manually by pressing the pushbutton on the front face of the WB75-A block.

Mounting

The WB75-A block is clipped onto the front face of the 1-stack contactor where it takes up two slots. The two other slots do not accept CA4 single pole auxiliary contacts. Up to 2 CAL4-11 auxiliary contact blocks can be side-mounted on contactors (except NF22E and AF..-22-00, refer to main accessory fitting details table in main accessories section).

Ordering details

For contactors	Rated control circuit voltage Uc		Catalog number	Global reference code	Pkg qty	Weight (1 pce) kg
	V 50 Hz or DC	V 60 Hz				
AF09 ... AF38 NF	24	24...28	WB75A-01	FPTN372726R1001	1	0.120
	42	42...48	WB75A-02	FPTN372726R1002	1	0.120
	48	48...55	WB75A-03	FPTN372726R1003	1	0.120
	110	110...127	WB75A-04	FPTN372726R1004	1	0.120
	220...230	220...255	WB75A-06	FPTN372726R1006	1	0.120
	230...240	230...277	WB75A-05	FPTN372726R1005	1	0.120
	380...415	380...440	WB75A-07	FPTN372726R1007	1	0.120
	415...440	440...480	WB75A-08	FPTN372726R1008	1	0.120

Note: For WB75-A produced since week 06-2012.

Other accessories



LDC4

Ordering details

For contactors	Catalog number	Global reference code	Pkg qty	Weight (1 pce)
				kg



BX4

Additional coil terminal blocks

Additional coil terminal blocks for contactors or control relays.

AF09 ... AF96, NF	LDC4	1SBN070156T1000	10	0.010
-------------------	------	-----------------	----	-------

Protective covers

Sealable and transparent protective covers BX4 and non-removable BX4-CA to protect the devices against accidental contact.

AF09 ... AF96 1-stack contactors and NF contactor relays	BX4	1SBN110108T1000	10	0.006
4-pole CA4, 2-pole CAT4 auxiliary contact blocks and TEF4 electronic timer	BX4-CA	1SBN110109W1000	50	0.001

Note: BX4 produced since 13045 (day 045 - year 2013) are suitable for AF40 ... AF96.



BX4-CA

Function markers AF09 ... AF370

Box of 16 blank cards (16 markers by card) printable on HTP500 thermal transfer printer and AMS 500 marking table to identify your contactors, overload relays or manual motor starters. Marker dimensions: 7 x 20 mm (.276" x .787").

AF09 ... AF370 contactors, TF thermal overload relays, EF electronic overload relays and MS116, MS132 manual motor starters	BA4	1SNA235156R2700	16	0.011
AMS 500 support plate for 8 BA4	XUSP02633	1SNA360010R1500	1	0.220
HTP500 support plate	HTP500-BA4	1SNA235712R2400	1	0.290



BA4

Function markers AF400 ... AF2650

Set of 50 function markers designed to be clipped onto the front face of devices. Details can be added to these markers using a ball point pen, indelible felt-tip pen or pentel white. Self-adhesive labels (not supplied) can also be added to them. Marker dimensions: 7 x 19 mm (.276" x .748").

AF400 ... AF2650 and accessories	BA5-50	1SBN110000R1000	50	0.017
----------------------------------	--------	-----------------	----	-------



BA5-50

Main dimensions mm, inches

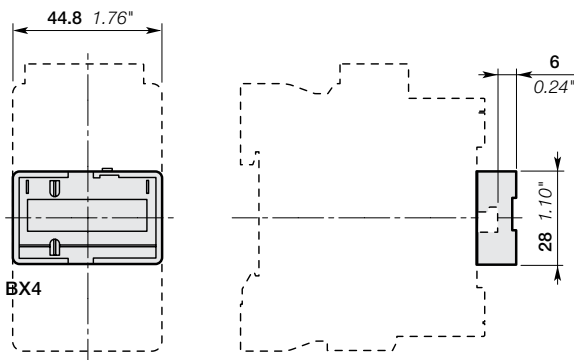

BX4

Other accessories



2

BP38-4



BDT4
For AF09 ... AF65, NF



BDT4
For AF80 ... AF96

Ordering details

For contactors	Catalog number	Global reference code	Pkg qty	Weight (1 pce)
				kg

Mounting pieces

Mounting piece for replacing A Line contactors mounted by screws with AF Range contactors.

From contactor	To contactor				
A26 ... A40, AL26 ... AL40	AF09 ... AF38	BP38-4	1SBN112303T1000	10	0.003
A40 ... A75, AE50 ... AE75, AF50 ... AF75	AF40 ... AF65	BP65-4	1SBN113403T1000	10	0.004
A95, A110, AE95, AE110, AF95, AF110	AF80 ... AF96	BP96-4	1SBN113903T1000	10	0.005

Test block

BDT4 test block is suitable for switching on contactor off-load.

Marking on the block indicates the contactor type to fit with.

AF09 ... AF96, NF	BDT4	1SBN110122T1000	10	0.007
-------------------	------	-----------------	----	-------

Main dimensions mm, inches

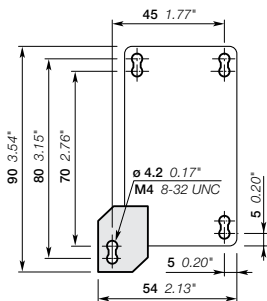

BP38-4

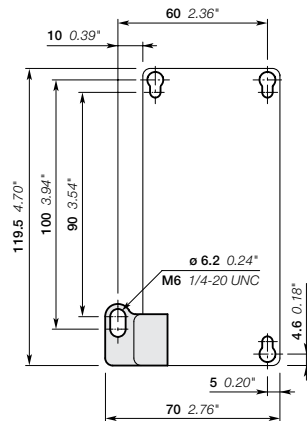

BP65-4

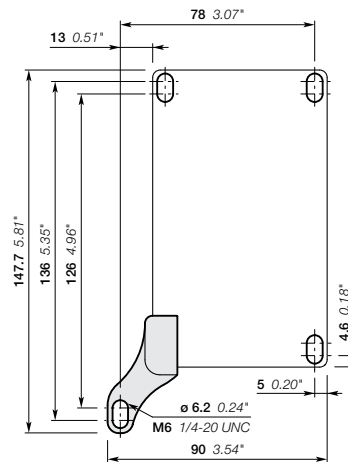

BP96-4

Terminal shrouds and mechanical lugs



LT140-30L



LT370-30C



LT460-AC



ATK185

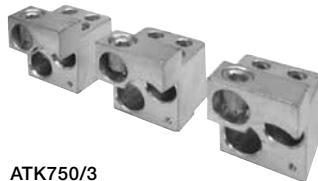

ATK750/3

Description

Main terminal protection for AF116 ... AF1250 contactors.

The auxiliary contact blocks and coils are designed to provide an IP 20 degree of protection.

The main terminals, equipped with compression lugs or cable clamps, can be protected against accidental direct contact after wiring (EN 50274) by the addition of terminal shrouds (see table below).

Ordering details

For contactors	Catalog number	Global reference code	Pkg qty	Weight (1 pce) kg
AF116 ... AF146, with compression lugs	LT140-30L	1SFN124203R1000	2	0.070
AF190, AF205, with cable clamps	LT205-30C	1SFN124801R1000	2	0.050
AF190, AF205, with compression lugs	LT205-30L	1SFN124803R1000	2	0.220
AF190, AF205, with shorting bar or between contactor and TOL/EOL in DOL starters	LT205-30Y	1SFN124804R1000	1	0.050
AF265 ... AF370, with cable clamps	LT370-30C	1SFN125401R1000	2	0.035
AF265 ... AF370, with compression lugs	LT370-30L	1SFN125403R1000	2	0.280
AF265 ... AF370, with shorting bar or between contactor and TOL/EOL in DOL starters	LT370-30Y	1SFN125404R1000	1	0.075
AF265 ... AF370, for use with extending cable clamps, ATK300/2 and OZXB4	LT370-30D	1SFN125406R1000	1	0.15
AF400, AF460 with cable clamps	LT460-AC	1SFN125701R1000	2	0.100
AF400, AF460 with compression lugs	LT460-AL	1SFN125703R1000	2	0.800
AF580, AF750 with cable clamps	LT750-AC	1SFN126101R1000	2	0.120
AF580, AF1250 with compression lugs	LT750-AL	1SFN126103R1000	2	0.825

Description

Large contactors (AF190 and above) include bar terminals as standard to easily facilitate the use of busbar as a means of internal wiring. Mechanical lugs are a common solution for allowing the use of stranded or solid wire, and are widely utilized for field wiring termination.

Ordering details

For contactors (1)	Description	Catalog number	Global reference code	Pkg qty	Weight (1 pce) kg
AF190, AF205	Lug kit, 1-wire, 4 AWG ... 300 MCM	ATK185	(2)	3	0.164
AF265 ... AF370	Lug kit, 1-wire, 4 AWG ... 400 MCM	ATK300	(2)	3	0.166
AF265 ... AF370	Lug kit, 2-wire, 4 AWG ... 500 MCM	ATK300/2	(2)	3	0.445
AF400 ... AF580	Lug kit, 2-wire, 2/0 AWG ... 500 MCM	ATK580/2	(2)	3	0.345
AF580, AF750	Lug kit, 3-wire, 2/0 AWG ... 500 MCM	ATK750/3	(2)	3	1.071
AF1350	Lug kit, 4-wire, 4/0 AWG ... 500 MCM (3)	ATK1350/4	(2)	3	1.883
AF1350, AF1650	Lug kit, 4-wire, 1/0 AWG ... 750 MCM (3)	ATK1650/4	(2)	3	3.353
AF1350, AF1650	Lug kit, 6-wire, 1/0 AWG ... 750 MCM (3)	ATK1650/6	(2)	3	4.378
AF190, AF205	Spare terminal hardware	LE185	1SFN074716R1000	1 set	0.200
AF265 ... AF370	Spare terminal hardware	LE300	1SFN075116R1000	1 set	0.300
AF400 ... AF580	Spare terminal hardware	LE460	1SFN075716R1000	1 set	0.600
AF580, AF750	Spare terminal hardware	LE750	1SFN076116R1000	1 set	0.750

(1) Note: AF1250, AF2050 & AF2650 intended for busbar connection only and terminal hardware is intended to be sourced separately.

(2) North American applications only.

(3) Note: Use of lug kits for AF1350 & AF1650 in general use applications reduces the ratings to 1050A and 1350A respectively. Recommend busbar connection for full ratings.

Terminal enlargements and extensions

2



LW140

Terminal enlargements

Description

Enlargement pieces designed to increase the width of the contactor terminal pads in order to allow larger connections to be mounted.

Ordering details

For contactors	Dimensions		Catalog number	Global reference code	Pkg qty	Weight (1 pce)
	hole Ø mm	bar mm				
AF116 ... AF146	6.5	13 x 3	LW140	1SFN074207R1000	1	0.115
AF190, AF205	10.5	17.5 x 5	LW205	1SFN074807R1000	1	0.260
AF265 ... AF370	10.5	20 x 5	LW370	1SFN075407R1000	1	0.340
AF400, AF460	10.5	25 x 5	LW460	1SFN075707R1000	1	0.730
AF580, AF750	13	40 x 6	LW750	1SFN076107R1000	1	1.230
AF1250	13	50 x 10	LW1250	1SFN076407R1000	1	2.000



LX140

Terminal extension

Description

Extension pieces designed to extend the main terminals of contactors for combined mounting of contactors and connection sets.

Ordering details

For contactors	Dimensions		Catalog number	Global reference code	Pkg qty	Weight (1 pce)
	hole Ø mm	bar mm				
AF116 ... AF146	6.5	13 x 3	LX140	1SFN074210R1000	1	0.072
AF190, AF205	8.5	17.5 x 5	LX205	1SFN074810R1000	1	0.180
AF265 ... AF370	10.5	20 x 5	LX370	1SFN075410R1000	1	0.234
AF400, AF460	10.5	25 x 5	LX460	1SFN075710R1000	1	0.500
AF580, AF750	13	40 x 6	LX750	1SFN076110R1000	1	0.850

Connection module

Description

Connection module can be fixed on AF116 ... AF146 delivered with bar terminals.



LD146-30

Ordering details

For contactor	Catalog number	Global reference code	Pkg qty	Weight (1 pce)
AF116 ... AF146	LD146-30	1SFN074208R1000	2	0.165

Terminal connecting strips and shorting bars



LY16-4



LY185



LH38-4



LF16-4



LG16-4

Description

Parallel and series connection of 3-pole contactors:

To obtain a star point (3 parallel-connected poles)

To connect poles in parallel and thus increase the AC load passing through the flow path made up of the parallel-connected poles: LP, LY, LH, LF, LG.

The relevant cable cross-sectional area may limit the maximum permissible current. Consult information in table below

To connect poles in series and thus increase the DC load controlled by the poles: LP, LY (only LY16-4 and LY38-4 selectable strips).

Types	for connection of "n" poles	with terminal	insulated
LP	n = 2	no	no (1)
LY	n = 2 (selectable LY16-4, LY38-4 connecting strips)	no	yes
	n = 3	no	yes (1)
LH	n = 2	yes	no
LF	n = 3	yes	yes
LG	n = 4	yes	yes

(1) LP460 ... LP750, LY185 ... LY750 not insulated. Use terminal shrouds.

Ordering details

For contactors	max. nominal continuous current with "n" poles				Cable cross-sectional area mm ²	Catalog number	Global reference code	Pkg qty	Weight (1 pce) kg
	in parallel		in series						
	2 poles	3 poles	4 poles	2 poles					
	A								
AF09	30	33	-	25	6	LY16-4	1SBN071303T1000	10	0.006
AF12	32	36	-	27					
AF16	34	40	-	30					
AF26	50	60	-	45	10	LY38-4	1SBN072303T1000	10	0.012
AF116 ... AF146	-	240	-	-	-	LY140	1SFN074203R1000	1	0.055
AF190, AF205	-	400	-	-	-	LY185	1SFN074703R1000	1	0.200
AF265 ... AF370	-	670	-	-	-	LY300	1SFN075103R1000	1	0.300
AF400, AF460	-	1000	-	-	-	LY460	1SFN075703R1000	1	0.450
AF580, AF750	-	1650	-	-	-	LY750	1SFN076103R1000	1	0.800
AF190, AF205	300	-	-	-	-	LP185	1SFN074712R1000	2	0.300
AF265 ... AF370	475	-	-	-	-	LP300	1SFN075112R1000	2	0.400
AF400, AF460	725	-	-	-	-	LP460	1SFN075712R1000	2	0.550
AF580, AF750	1200	-	-	-	-	LP750	1SFN076112R1000	2	0.950
AF09	45	-	-	-	10	LH38-4	1SBN072304R1000	2	0.012
AF12	50	-	-	-	10				
AF16	54	-	-	-	16				
AF26	81	-	-	-	25				
AF30, AF38	90	-	-	-	25				
AF09	-	62	-	-	16	LF16-4	1SBN071305R1000	2	0.020
AF12	-	70	-	-	25				
AF16	-	75	-	-	25				
AF26	-	112	-	-	35	LF38-4	1SBN072305R1000	2	0.040
AF30, AF38	-	125	-	-	50				
AF09	-	-	70	-	25	LG16-4	1SBN071306R1000	2	0.025
AF12	-	-	78	-	25				
AF16	-	-	84	-	25				

Main dimensions

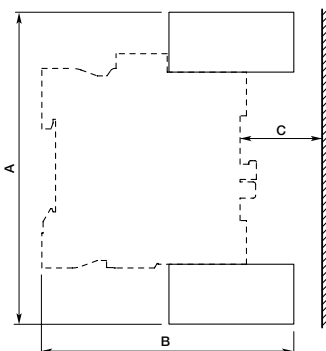

Type	For contactors	Dimensions					
		A		B		C	
		mm	inch	mm	inch	mm	inch
LH38-4	AF09 ... AF16	111.20	4.38"	83	3.27"	22	0.87"
	AF26 ... AF38	114	4.49"	86	3.39"	16	0.63"
LF16-4	AF09 ... AF16	121	4.76"	87	3.43"	23	0.91"
LF38-4	AF26 ... AF38	135.20	5.32"	103	4.06"	31	1.22"
LG16-4	AF09 ... AF16	124.20	4.89"	87	3.43"	23	0.91"

Reversing and phase-to-phase bus kits

2

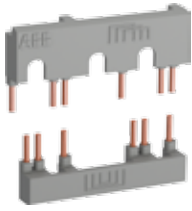

BER16-4

Connection sets for reversing contactors

Description

The BER and BEM connection sets are used to connect the main poles of two 3-pole contactors mounted side by side.

The BER connection sets are made up of 1 upstream and 1 downstream connections.

The BEM connection sets are made up of 3 upstream and 3 downstream connections.

BER and BEM connection sets are insulated and made of solid copper bars.

Ordering details

For 3-pole contactors	Catalog number	Global reference code	Pkg qty	Weight (1 pce) kg
AF09 ... AF16	BER16-4	1SBN081311R1000	1	0.045
AF26 ... AF38	BER38-4	1SBN082311R1000	1	0.100
AF40 ... AF65	BER65-4	1SBN083411R1000	1	0.175
AF80, AF96	BER96-4	1SBN083911R1000	1	0.250
AF116 ... AF146	BER140-4	1SFN084211R1000	1	0.615
AF190, AF205	BER205-4	1SFN084811R1000	1	1.237
AF265 ... AF370	BER370-4	1SFN085411R1000	1	2.140
AF400, AF460	BEM460-30	1SFN085701R1000	1	4.400
AF580, AF750	BEM750-30	1SFN086101R1000	1	7.300

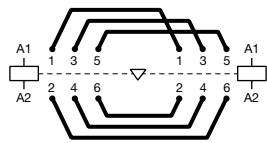

BER, BEM
Reversing connections



BEP140-30

3-pole phase to phase connections

Description

The BEP and BES connection sets are used to connect phase to phase the main poles of two 3-pole contactors mounted side by side.

The BEP connection sets are made up of 1 upstream or downstream connections.

The BES connection sets are made up of 3 upstream or downstream connections.

BEP and BES connection sets are insulated and made of solid copper bars.

Ordering details

For 3-pole contactors	Catalog number	Global reference code	Pkg qty	Weight (1 pce) kg
AF116 ... AF146	BEP140-30	1SFN084214R1000	1	0.320
AF190, AF205	BEP205-30	1SFN084814R1000	1	0.534
AF265 ... AF370	BEP370-30	1SFN085414R1000	1	0.926
AF400, AF460	BES460	1SFN085704R1000	1	2.200
AF580, AF750	BES750	1SFN086104R1000	1	3.700

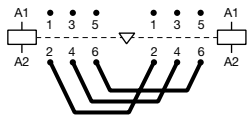

BEP, BES
Phase to phase connections

Wye-delta bus kits

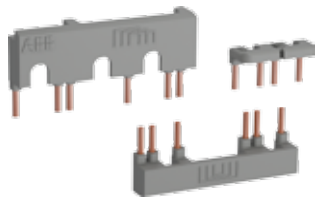

BEY16-4

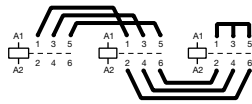

AF09 ... AF750
1M - 2M -1S

Description

The BEY and BED connection sets are used to connect the main poles of the Line, Delta and Wye contactors of a wye-delta starter.

The connection sets are made up of:

- Line contactor / delta contactor:
 - BEY: upstream phase-to-phase connection
 - BED: upstream connection in parallel
- Delta contactor / Wye contactor: downstream connection in parallel
- Wye contactor: Wye point upstream
- Insulated, solid copper bar.

Ordering details

For 3-pole line, delta & wye contactors	Interlock unit between delta & wye contactors	Catalog number	Global reference code	Pkg qty	Weight (1 pce) kg
AF09 ... AF16	With or without VM4 or VEM4	BEY16-4	1SBN081313R2000	1	0.050
AF26 ... AF38	With or without VM4 or VEM4	BEY38-4	1SBN082713R2000	1	0.110
AF40 ... AF65	With or without VM96-4	BEY65-4	1SBN083413R2000	1	0.200
AF80, AF96	With or without VM96-4	BEY96-4	1SBN083913R2000	1	0.250
AF116 ... AF146	With or without VM19	BEY140-4	1SFN084413R1000	1	1.040
AF190 ... AF205 (line and delta) AF140 ... AF146 (wye)	With or without VM140/190	BEY190-4	1SFN084813R1000	1	1.154
AF190, AF205	With or without VM19	BEY205-4	1SFN085213R1000	1	1.205
AF265 ... AF370 (line and delta) AF190 ... AF205 (wye)	With or without VM205/265	BEY265-4	1SFN085413R1000	1	2.020
AF265 ... AF370	With or without VM19	BEY370-4	1SFN085813R1000	1	2.110
AF400 ... AF460	With or without VM750H	BED460U	-	1	4.700
AF580 ... AF750 (line and delta) AF400 ... AF460 (wye)	With or without VM750H	BED580U	-	1	6.300
AF580 ... AF750	With or without VM750H	BED750U	-	1	7.700

Coupling units

2

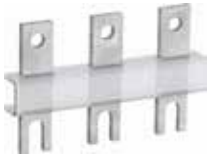

BEA140/XT2



BEA205/T4



BEA370/T5

Connection bars between contactors and MCCB

Description

Connection between contactors/starters and moulded case circuit breakers.
These connection sets are solid copper bars.

Ordering details

For contactors	MCCB	Catalog number	Global reference code	Pkg qty	Weight (1 pce) kg
Vertical assembly					
AF116 ... AF146	XT2	BEA140/XT2	1SFN084206R1000	1	0.058
AF116 ... AF146	XT4	BEA140/XT4	1SFN084206R1001	1	0.068
AF190, AF205	XT4	BEA205/XT4	1SFN084806R1000	1	0.200
AF190, AF205	T4	BEA205/T4	1SFN084806R1001	1	0.190
AF265 ... AF370	T5	BEA370/T5	1SFN085406R1000	1	0.350
AF400 ... AF750	T6	BEA750/T6	1SFN086106R1000	1	0.410
AF400 ... AF750	T5	BEA750/T5	1SFN086106R1001	1	0.410
Vertical assembly with control wire terminals (also suitable when using busbar kits for starter combinations)					
AF400 ... AF750	T5	BEA750D/T5	1SFN086106R1003	1	0.720
AF400 ... AF750	T6	BEA750D/T6	1SFN086106R1002	1	0.720
Horizontal assembly (also suitable when using busbar kits for starter combinations)					
AF400, AF460	T4	BEA460H/T4	1SFN085907R1000	1	2.450

Connection bars between contactors and fusible disconnects

Description

Connection between contactors/starters and fusible disconnect switches.
These connection sets are solid copper bars.

Ordering details

For contactors	Switch fuse	Catalog number	Global reference code	Pkg qty	Weight (1 pce) kg
Vertical assembly					
AF400, AF460	OESA400	BEF460/OESA400	1SFN085708R1000	1	0.340
AF460 ... AF750	OESA630 to OESA800	BEF750/OESA800	1SFN086108R1000	1	0.740
Horizontal assembly					
AF400, AF460	OESA400...LR	OESA460H/OESA400	1SFN085709R1000	1	1.250

Note: The BEF connection bars provided for the A145 ... A300 contactors can be used for the AF145 ... AF300 contactors.

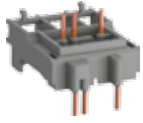

BEA16-4

Connecting links with manual motor starters

Description

The BEA insulated 3-pole connecting links are used to connect AF09 ... AF38 contactors with the MS116 or MS132 manual motor starters. The BEA insulated 3-pole connecting links ensure the electrical and mechanical connection between the contactor and the associated manual motor starter.

Ordering details

For 3-pole contactors	Manual motor starter	Catalog number	Global reference code	Pkg qty	Weight (1 pce) kg
AF09 ... AF16	MS116-0.16 ... MS116-25, MS132-0.16... MS132-25	BEA16-4	1SBN081306T1000	10	0.025
AF26 ... AF38	MS116-0.16 ... MS116-16, MS132-0.16 ... MS132-10	BEA26-4	1SBN082306T1000	10	0.025
	MS116-20 ... MS116-32, MS132-12 ... MS132-32	BEA38-4	1SBN082306T2000	10	0.030

Mounting plates

2



PN460

Description

Mounting plates with fixing holes for the specified contactors and overload relays.

Ordering details

For contactors	For overload relays	Catalog number	Global reference code	Pkg qty	Weight (1 pce)
					kg

Mounting plates for Direct on line starters

AF400, AF460	E500DU	PN460-11	1SFN095705R1000	1	2.120
AF580, AF750	E800DU	PN750-11	1SFN096105R1000	1	2.500

For two contactors side by side with space for mechanical interlock	For one or two overload relays	Catalog number	Global reference code	Pkg qty	Weight (1 pce)
					kg

Mounting plates for mechanical interlocked contactors, reversing starters and two speed starters for double windings

AF400, AF460	E500DU	PN460-21	1SFN095701R1000	1	3.490
AF580, AF750	E800DU	PN750-21	1SFN096101R1000	1	4.230

For main and delta contactors	For wye contactor (1)	For overload relays	Catalog number	Global reference code	Pkg qty	Weight (1 pce)
						kg

Mounting plates for wye-delta starters and two speed starters for single windings

AF400, AF460	A300, AF400	E500DU	PN460-41	1SFN095703R1000	1	5.310
AF580, AF750	AF400 ... AF580	E800DU	PN750-41	1SFN096103R1000	1	6.320

(1) Space for mechanical interlock included.

Adapter plates

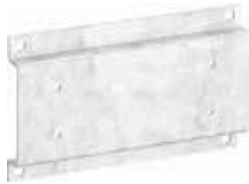

PR146-1

Description

Adapter plates with fixing holes for replacing installed contactors.

Ordering details

From contactors	To contactor	Catalog number	Global reference code	Pkg qty	Weight (1 pce)
A95, AF95, A110, AF110	AF116, AF140, AF146	PR146-1	1SFN094200R1000	1	0.300
EH150, EH160, EH175, EH210, EG160	AF190, AF205	PR210-1	1SFN094900R1000	1	0.440
EH250, EH260, EH300	AF265, AF305, AF370	PR300-1	1SFN095300R1000	1	0.560
EH370, EH550, EG315	AF400, AF460, AF580	PR460-1	1SFN095700R1000	1	0.900
EH700, EH800	AF750	PR750-1	1SFN096100R1000	1	0.500
OKYM150, OKYM175	AF190	PR185-2	1SFN095100R1001	1	0.500
OKYM200, OKYM250	AF265, AF305, AF370	PR300-2	1SFN095300R1001	1	0.500
OKYM315	AF400, AF460	PR400-2	1SFN095700R1002	1	0.820
OKYM400	AF400, AF460	PR460-2	1SFN095700R1001	1	0.800
OKYM500	AF580	PR580-2	1SFN096100R1002	1	0.700
EH550, EG630, OKYM630	AF580, AF750	PR750-2	1SFN096100R1001	1	1.100

Note: for smaller devices, see mounting pieces on the other accessories page.

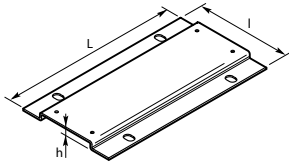

Dimensions (mm)

Type of the plate	Dimensions			Fixing holes mm
	L	l	h	
PR146-1	150	90	15	4 x \varnothing 6.5
PR210-1	200	132	11.5	4 x \varnothing 7
PR300-1	200	172	11.5	4 x \varnothing 7
PR460-1	278	198	11.5	4 x \varnothing 7
PR750-1	283	244	11.5	4 x \varnothing 7
PR185-2	202	152	11.2	4 x \varnothing 11
PR300-2	202	152	11.2	4 x \varnothing 11
PR400-2	278	151	11.5	4 x \varnothing 11
PR460-2	278	176	11.5	4 x \varnothing 11
PR580-2	283	176	11.5	4 x \varnothing 11
PR750-2	283	255	11.5	4 x \varnothing 14

Fixing holes according to the plate types